

Type	
Project	
Notes	

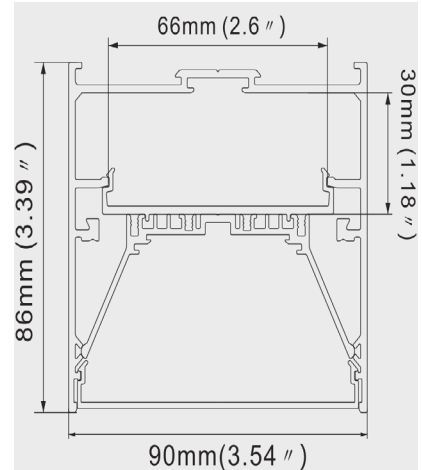

## Linear Luminaire - L9086



### PRODUCT SPECIFICATIONS

Model	L9086
Length	1200mm or 2500mm
Lumen Output	118 lm/W or 108lm/W
CRI	80 or 90
Voltage	100 - 277V AC 347V AC
Colour Temperature	3000k 3500k 4000k 5000k RGBW
Installation	Pendant Recessed Surface mounted
Beam Angle	95 (PDM) or 65 (UGR <19)
Certification	cETLus, CE, RoHS
Warranty	5 years



PDM Cover

UGR<19 Cover



# ORDER FORM

L9086										
1	2	3	4	5	6	7	8	9	OPTIONS	

1. FAMILY	2. SIZE	3. OUTPUT LEVEL	CRI*	4. VOLTAGE
L9086	12 1200mm 25 2500mm	A 708 lm@ 6 W / ft B 1180 lm@ 10 W / ft C 648 lm@ 6 W / ft D 1080 lm@ 10 W / ft	80 80 90 90	27 100 - 277V AC 34 347V AC

\*Lumen output and CRI have restricted corresponding values

5. CCT	6. INSTALLATION	7. COLOUR	8. DIMMING	9. LENS
30 3000K 35 3500K 40 4000K 50 5000K 60 RGBW	P Pendant R Recessed S Surface mounted	1 Silver 2 Black 3 White	1D No Dimming 2D 0-10V Dimming 3D TRIAC Dimming 4D DMX 5D Dali 6D Lutron Hi-Lume	95 PDM 65 UGR < 19

OPTIONS	MOUNTING	CONNECTORS	ACCOUSTIC
	M1 L-PTB M2 L-PT M3 L9086-BI M4 L-SM M5 L-PTB-NPF M6 L-PTB-PF	C1 L-9086-90L C2 L-9086-90W C3 L-9086-90N C4 L-9086-90T C5 L-9086-90X C6 L-79-180	A1 Sound Absorption

## OPTIONAL ACCESSORIES

### MOUNTING

- M1 L-PTB
- M2 L-PT
- M3 L9086-BI
- M4 L-SM
- M5 L-PTB-NPF
- M6 L-PTB-PF

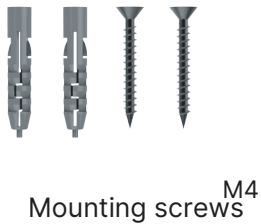

### CONNECTORS

- C1 L-9086-90L
- C2 L-9086-90W
- C3 L-9086-90N
- C4 L-9086-90T
- C5 L-9086-90X
- C6 L-79-180

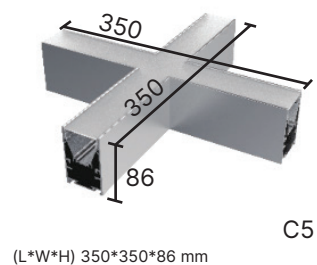
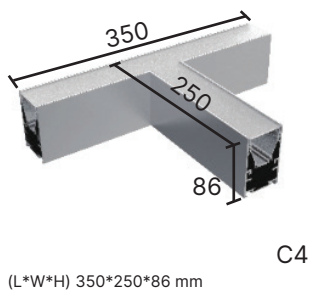
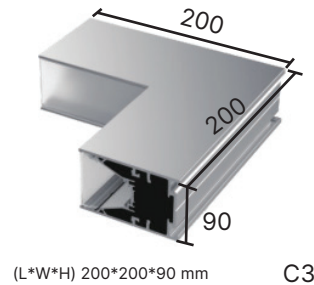
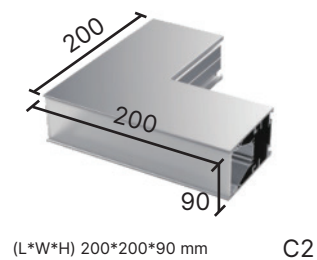
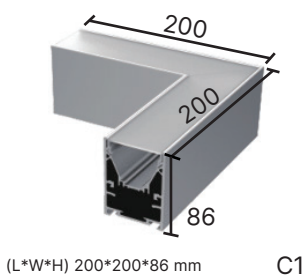

## Sound Absorption Features



Sound Absorption  
 Accoustic Standard NRC0.75



Damp-proof rated  
 Anti-moisture



Eco-friendly  
 Made out of polyester fibre

## Diagram

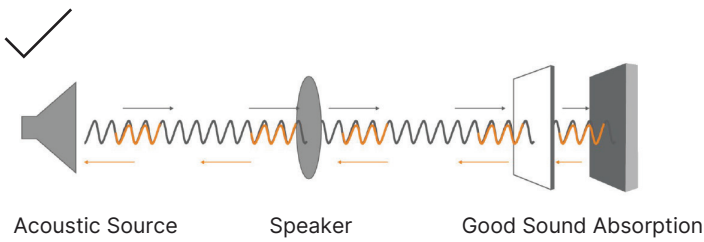

## Colour Cards

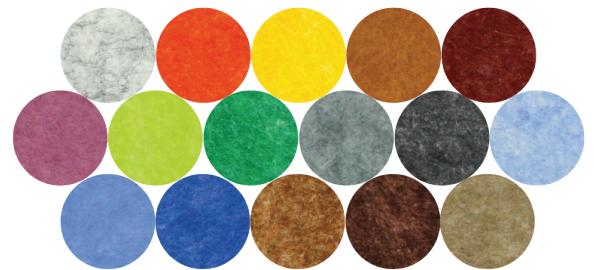

Poor quality sound absorption  
 material reflects the sound

