

Type	
Project	
Notes	

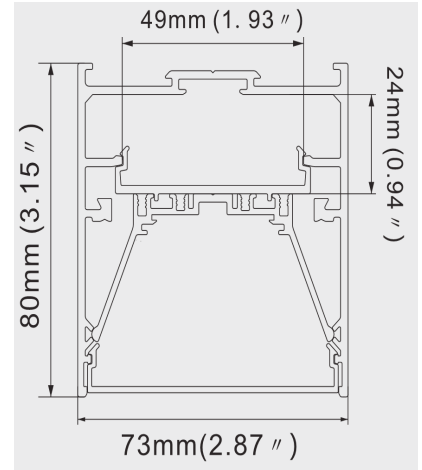

Linear Luminaire - L7380



PRODUCT SPECIFICATIONS

Model	L7380
Length	1200mm or 2500mm
Lumen Output	115 lm/W or 100lm/W
CRI	80 or 90
Voltage	100 - 277V AC 347V AC
Colour Temperature	3000k 3500k 4000k 5000k RGBW
Installation	Pendant Recessed Surface mounted Wall mounted
Beam Angle	95 (PDM) or 65 (UGR <19)
Certification	cETLus, CE, RoHS
Warranty	5 years

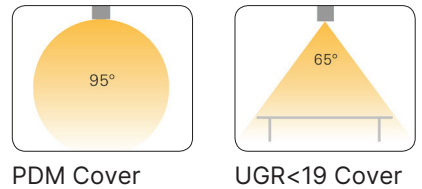
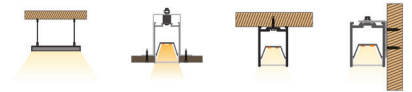

ORDER FORM

L7380										
1	2	3	4	5	6	7	8	9	OPTIONS	

1. FAMILY	2. SIZE	3. OUTPUT LEVEL	CRI*	4. VOLTAGE
L7380	12 1200mm 25 2500mm	A 690 lm@ 6 W / ft B 1150 lm@ 10 W / ft C 600 lm@ 6 W / ft D 1000 lm@ 10 W / ft	80 80 90 90	27 100 - 277V AC 34 347V AC

*Lumen output and CRI have restricted corresponding values

5. CCT	6. INSTALLATION	7. COLOUR	8. DIMMING	9. LENS
30 3000K 35 3500K 40 4000K 50 5000K 60 RGBW	P Pendant R Recessed S Surface mounted W Wall mounted	1 Silver 2 Black 3 White	1D No Dimming 2D 0-10V Dimming 3D TRIAC Dimming 4D DMX 5D Dali 6D Lutron Hi-Lume	95 PDM 65 UGR < 19

OPTIONS	MOUNTING	CONNECTORS	ACCOUSTIC
	M1 L-PTB M2 L-PT M3 L7380-BI M4 L457-WM M5 L-PTB-NPF M6 L-PTB-PF M7 L-SM	C1 L-7380-90L C2 L-7380-90W C3 L-7380-90N C4 L-7380-90T C5 L-7380-90X C6 L-79-180	A1 SOUND ABSORPTION

OPTIONAL ACCESSORIES

MOUNTING

- M1 L-PTB
- M2 L-PT
- M3 L7380-BI
- M4 L457-WM
- M5 L-PTB-NPF
- M6 L-PTB-PF
- M7 L-SM

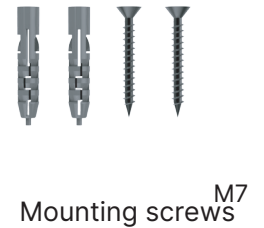

CONNECTORS

- C1 L-7380-90L
- C2 L-7380-90W
- C3 L-7380-90N
- C4 L-7380-90T
- C5 L-7380-90X
- C6 L-79-180

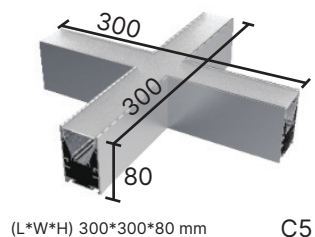
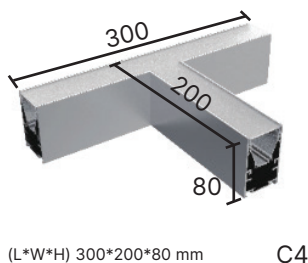
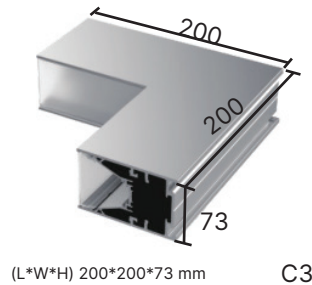
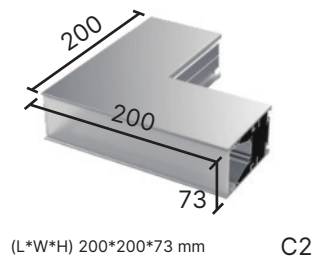
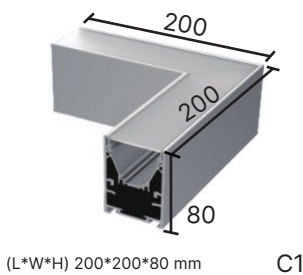

Sound Absorption Features



Sound Absorption
 Accoustic Standard NRC0.75



Damp-proof rated
 Anti-moisture



Eco-friendly
 Made out of polyester fibre

Diagram

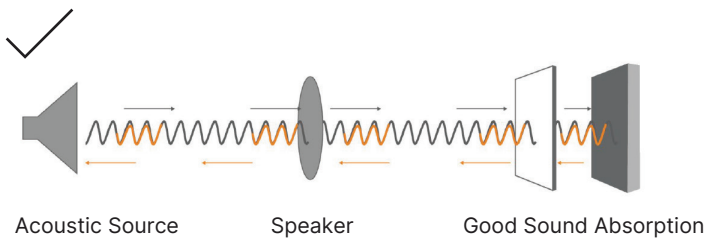

Colour Cards

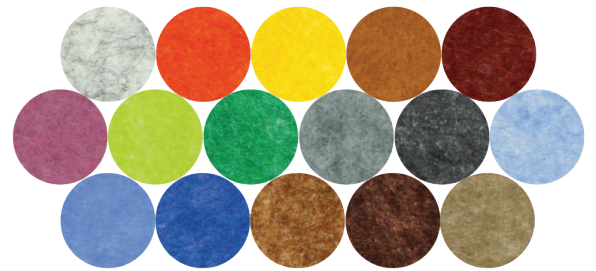

Poor quality sound absorption
 material reflects the sound

