

Type	
Project	
Notes	

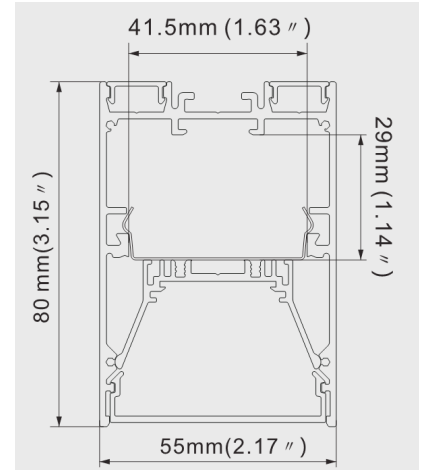

Linear Luminaire - L5580D

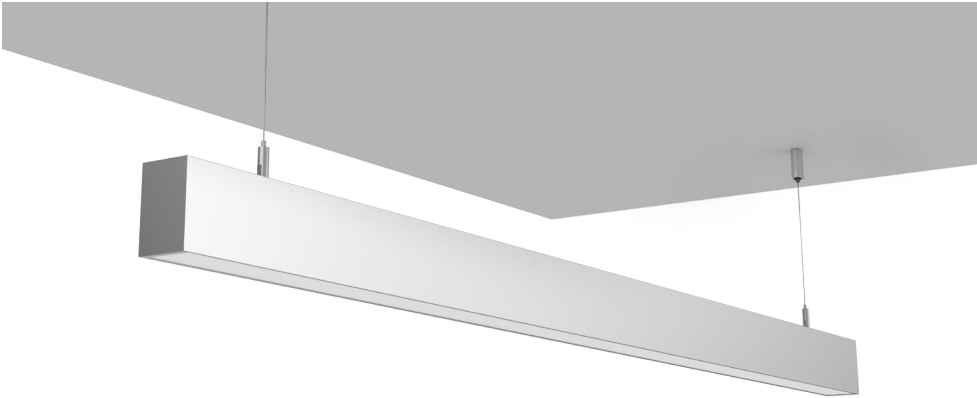

PRODUCT SPECIFICATIONS

Model	L5580D
Length	1200mm or 2500mm
Lumen Output	110 lm/W or 100 lm/W
CRI	80 or 90
Voltage	100 - 277V AC 347V AC
Colour Temperature	3000k 3500k 4000k 5000k RGBW
Installation	Pendant Wall mounted
Beam Angle	95 (PDM) or 70 (UGR < 19)
Certification	cETLus, CE, RoHS
Warranty	5 years

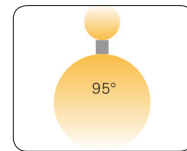
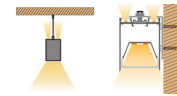

PDM Cover

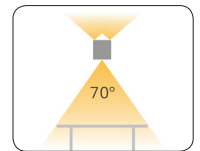

UGR<19 Cover



ORDER FORM

L5580D											
1	2	3	4	5	6	7	8	9	10	OPTIONS	

1. FAMILY	2. SIZE	3. OUTPUT LEVEL	CRI*	4. VOLTAGE	5. CCT (Up)
L5580D	12 1200mm	A 660 lm @ 6 W / ft	80	27 100 - 277V AC	30 3000K
	25 2500mm	B 1100 lm @ 10 W / ft	80	34 347V AC	35 3500K
		C 600 lm @ 6 W / ft	90		40 4000K
		D 1000 lm @ 10 W / ft	90		50 5000K

*Lumen output and CRI have restricted corresponding values

6. CCT (Down)	7. INSTALLATION	8. COLOUR	9. DIMMING	10. LENS (Down only)
30 3000K	P Pendant	1 Silver	1D No Dimming	95 PDM
35 3500K	W Wall mounted	2 Black	2D 0-10V Dimming	70 UGR < 19
40 4000K		3 White	3D TRIAC Dimming	
50 5000K			4D DMX	
60 RGBW			5D Dali	
			6D Lutron Hi-Lume	

OPTIONS	MOUNTING	CONNECTORS
	M1 L-PTB-S	C1 L-5580D-90L
	M2 L-PT-S	C2 L-5580D-90W
	M3 L5580D-WM	C3 L-5580D-90N
	M4 L-PTB-NPF-S	C4 L-5580D-90T
	M5 L-PTB-PF-S	C5 L-5580D-90X
		C6 L-45-180

OPTIONAL ACCESSORIES

MOUNTING

- M1** L-PTB-S
- M2** L-PT-S
- M3** L5580D-WM
- M4** L-PTB-NPF-S
- M5** L-PTB-PF-S



M1



M2



Wall mounting bracket M3



M4

Suspension cable without power feed



M5

Suspension cable with power feed

CONNECTORS

- C1** L-5580D-90L
- C2** L-5580D-90W
- C3** L-5580D-90N
- C4** L-5580D-90T
- C5** L-5580D-90X
- C6** L-45-180

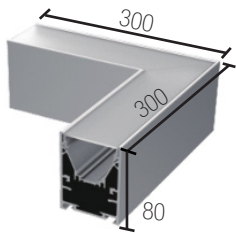

(L*W*H) 300*300*80 mm

C1

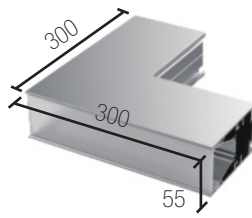

(L*W*H) 300*300*55 mm

C2

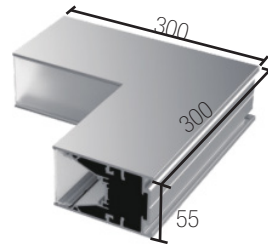

(L*W*H) 300*300*55 mm

C3

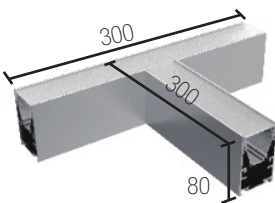

(L*W*H) 300*300*80 mm

C4

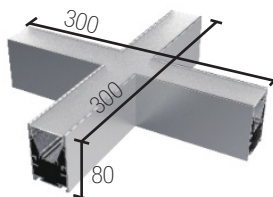

(L*W*H) 300*300*80 mm

C5



Connection bracket C6