

Type	
Project	
Notes	

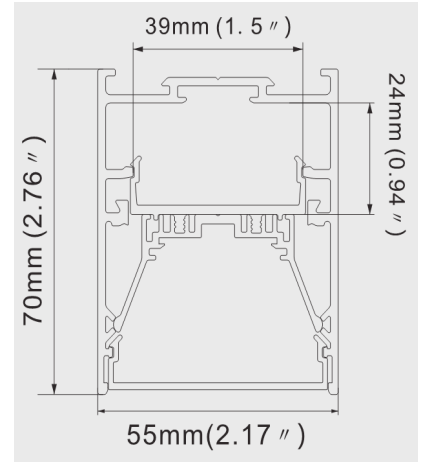

Linear Luminaire - L5570

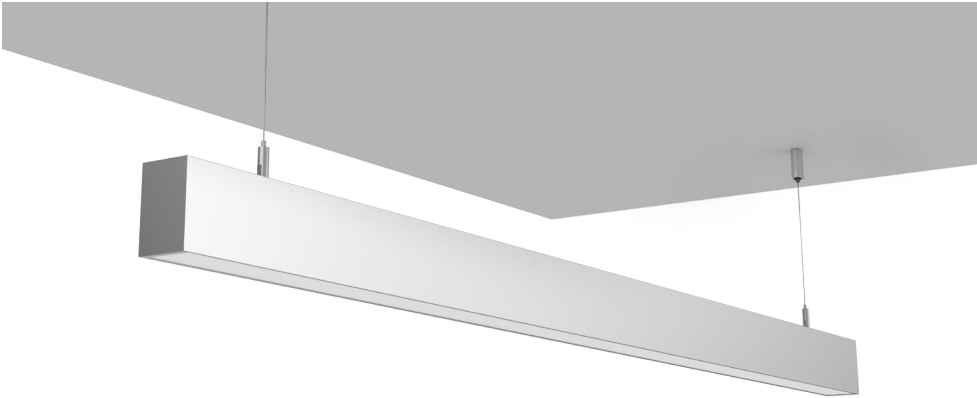

PRODUCT SPECIFICATIONS

Model	L5570
Length	1200mm or 2500mm
Lumen Output	110 lm/W or 97 lm/W
CRI	80 or 90
Voltage	100 - 277V AC 347V AC
Colour Temperature	3000k 3500k 4000k 5000k RGBW
Installation	Pendant Recessed Surface mounted Wall mounted
Beam Angle	95 (PDM) or 65 (UGR < 19)
Certification	cETLus, CE, RoHS
Warranty	5 years

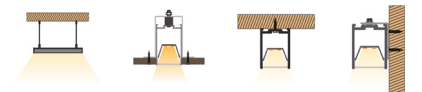

PDM Cover

UGR<19 Cover



ORDER FORM

L5570										
1	2	3	4	5	6	7	8	9	OPTIONS	

1. FAMILY	2. SIZE	3. OUTPUT LEVEL	CRI*	4. VOLTAGE
L5570	12 1200mm 25 2500mm	A 660 lm @ 6 W / ft B 1100 lm @ 10 W / ft C 582 lm @ 6 W / ft D 970 lm @ 10 W / ft	80 80 90 90	27 100 - 277V AC 34 347V AC

*Lumen output and CRI have restricted corresponding values

5. CCT	6. INSTALLATION	7. COLOUR	8. DIMMING	9. LENS
30 3000K 35 3500K 40 4000K 50 5000K 60 RGBW	P Pendant R Recessed S Surface mounted W Wall mounted	1 Silver 2 Black 3 White	1D No Dimming 2D 0-10V Dimming 3D TRIAC Dimming 4D DMX 5D Dali 6D Lutron Hi-Lume	95 PDM 65 UGR < 19

OPTIONS	MOUNTING	CONNECTORS
	M1 L-PTB M2 L-PT M3 L5570-BI M4 L457-WM M5 L-PTB-NPF M6 L-PTB-PF	C1 L-5570-90L C2 L-5570-90W C3 L-5570-90N C4 L-5570-90T C5 L-5570-90X C6 L-45-180

OPTIONAL ACCESSORIES

MOUNTING

- M1** L-PTB
- M2** L-PT
- M3** L5570-BI
- M4** L457-WM
- M5** L-PTB-NPF
- M6** L-PTB-PF



M1



M2



M3

Recess mounting clip



M4

Wall mounting bracket



M5

Suspension cable without
power feed



M6

Suspension cable with
power feed

CONNECTORS

- C1** L-5570-90L
- C2** L-5570-90W
- C3** L-5570-90N
- C4** L-5570-90T
- C5** L-5570-90X
- C6** L-45-180

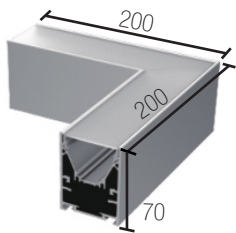

(L*W*H) 200*200*70 mm

C1

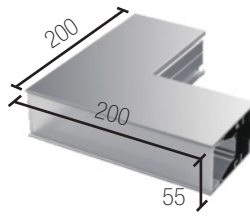

(L*W*H) 200*200*55 mm

C2

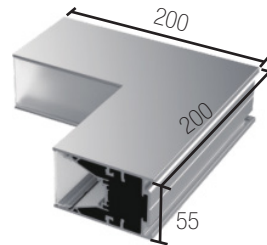

(L*W*H) 200*200*55 mm

C3

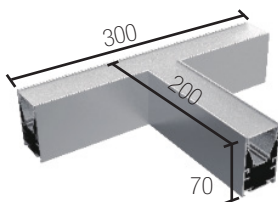

(L*W*H) 300*200*70 mm

C4

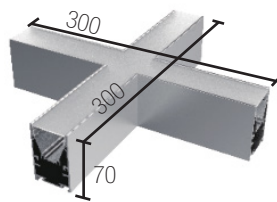

(L*W*H) 300*300*70 mm

C5



Connection bracket

C6